

# OSRAM

## LUXPOINT®

### LED Floodlight - Kämpig

25000  
Hours

220-240V  
50/60Hz

100°

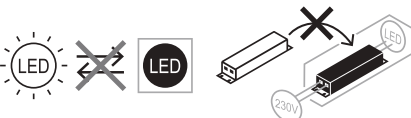
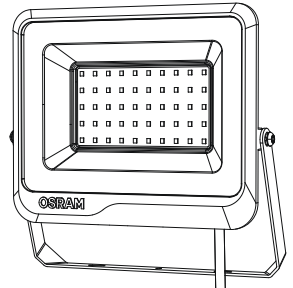
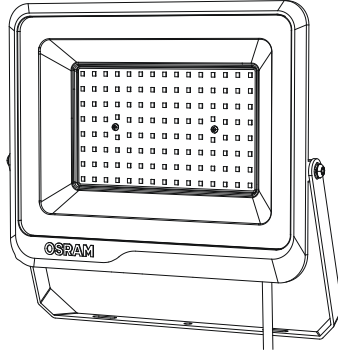
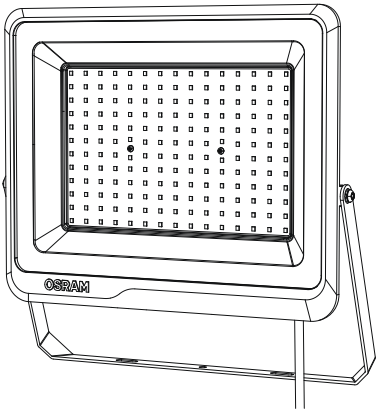
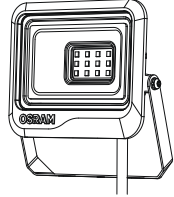
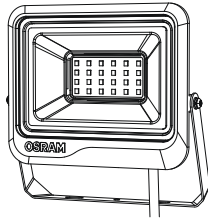
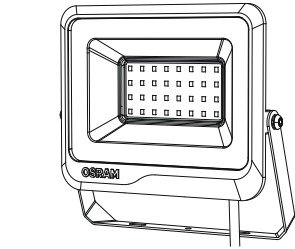





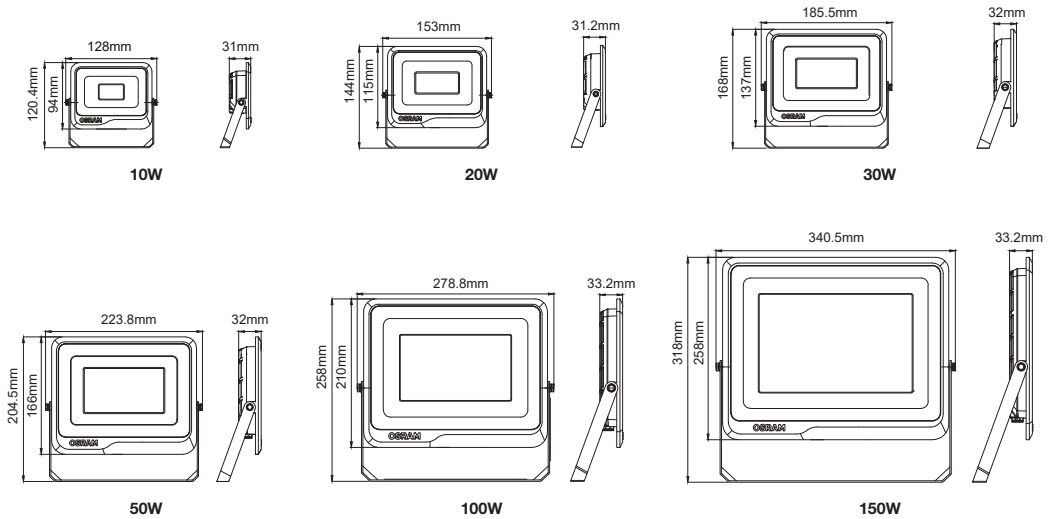

IP65

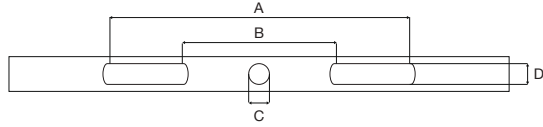
IK08



Model	Voltage	Fixture Lumen / Light source Lumen	Ra	CCT	LxWxH(mm)	Life hours	Beam Angle	Weight	Item code / 	Energy Class of Light source
LP FL 10W 830 SF BL LP FL 10W 830 SF WH	220-240V	1100lm / 1150lm	80	3000K	128x120.4x31	50000hrs	100°	230g	GL24100554155 GL24100554455	E
LP FL 10W 840 SF BL LP FL 10W 840 SF WH	220-240V	1150lm / 1250lm	80	4000K	128x120.4x31	50000hrs	100°	230g	GL24100554255 GL24100554555	E
LP FL 10W 865 SF BL LP FL 10W 865 SF WH	220-240V	1150lm / 1250lm	80	6500K	128x120.4x31	50000hrs	100°	230g	GL24100554355 GL24100554655	E
LP FL 20W 830 SF BL LP FL 20W 830 SF WH	220-240V	2200lm / 2300lm	80	3000K	153x144x31.2	50000hrs	100°	330g	GL24100554755 GL24100555055	E
LP FL 20W 840 SF BL LP FL 20W 840 SF WH	220-240V	2300lm / 2500lm	80	4000K	153x144x31.2	50000hrs	100°	330g	GL24100554855 GL24100555155	E
LP FL 20W 865 SF BL LP FL 20W 865 SF WH	220-240V	2300lm / 2500lm	80	6500K	153x144x31.2	50000hrs	100°	330g	GL24100554955 GL24100555255	E
LP FL 30W 830 SF BL LP FL 30W 830 SF WH	220-240V	3300lm / 3450lm	80	3000K	185.5x168x32	50000hrs	100°	490g	GL24100555355 GL24100555655	E
LP FL 30W 840 SF BL LP FL 30W 840 SF WH	220-240V	3450lm / 3750lm	80	4000K	185.5x168x32	50000hrs	100°	490g	GL24100555455 GL24100555755	E
LP FL 30W 865 SF BL LP FL 30W 865 SF WH	220-240V	3450lm / 3750lm	80	6500K	185.5x168x32	50000hrs	100°	490g	GL24100555555 GL24100555855	E
LP FL 50W 830 SF BL LP FL 50W 830 SF WH	220-240V	5500lm / 5750lm	80	3000K	223.8x204.5x32	50000hrs	100°	720g	GL24100555955 GL24100556255	E
LP FL 50W 840 SF BL LP FL 50W 840 SF WH	220-240V	5750lm / 6250lm	80	4000K	223.8x204.5x32	50000hrs	100°	720g	GL24100556055 GL24100556355	E
LP FL 50W 865 SF BL LP FL 50W 865 SF WH	220-240V	5750lm / 6250lm	80	6500K	223.8x204.5x32	50000hrs	100°	720g	GL24100556155 GL24100556455	E
LP FL 100W 830 SF BL LP FL 100W 830 SF WH	220-240V	11000lm / 11500lm	80	3000K	278.8x258x33.2	50000hrs	100°	1170g	GL24100556555 GL24100556855	E
LP FL 100W 840 SF BL LP FL 100W 840 SF WH	220-240V	11500lm / 12500lm	80	4000K	278.8x258x33.2	50000hrs	100°	1170g	GL24100556655 GL24100556955	E
LP FL 100W 865 SF BL LP FL 100W 865 SF WH	220-240V	11500lm / 12500lm	80	6500K	278.8x258x33.2	50000hrs	100°	1170g	GL24100556755 GL24100557055	E
LP FL 150W 830 SF BL LP FL 150W 830 SF WH	220-240V	16500lm / 17250lm	80	3000K	340.5x318x33.2	50000hrs	100°	1740g	GL24100557155 GL24100557455	E
LP FL 150W 840 SF BL LP FL 150W 840 SF WH	220-240V	17250lm / 18750lm	80	4000K	340.5x318x33.2	50000hrs	100°	1740g	GL24100557255 GL24100557555	E
LP FL 150W 865 SF BL LP FL 150W 865 SF WH	220-240V	17250lm / 18750lm	80	6500K	340.5x318x33.2	50000hrs	100°	1740g	GL24100557355 GL24100557655	E



Product	A (mm)	B (mm)	C (mm)	D (mm)			 B16	 C10	 C16
10W	70mm	50mm	4.5mm	4.5mm	M4	Ø4mm	676	703	1149
20W	80mm	60mm	4.5mm	4.5mm	M4	Ø4mm	216	224	367
30W	100mm	80mm	4.5mm	4.5mm	M6	Ø4mm	209	217	355
50W	120mm	100mm	4.5mm	4.5mm	M6	Ø4mm	89	92	151
100W	170mm	140mm	6.5mm	6.5mm	M6	Ø5mm	63	65	107
150W	170mm	140mm	6.5mm	6.5mm	M6	Ø5mm	82	85	139

**1**

x 2

x 2

**OFF**

**2**

Ø8mm

E mm

Product	E (mm)
10W	60mm
20W	70mm
30W	90mm
50W	110mm
100W	155mm
150W	155mm

**3**

**4**

Product	
10W	0.6Nm
20W	0.6Nm
30W	0.6Nm
50W	0.6Nm
100W	1Nm
150W	1Nm

5

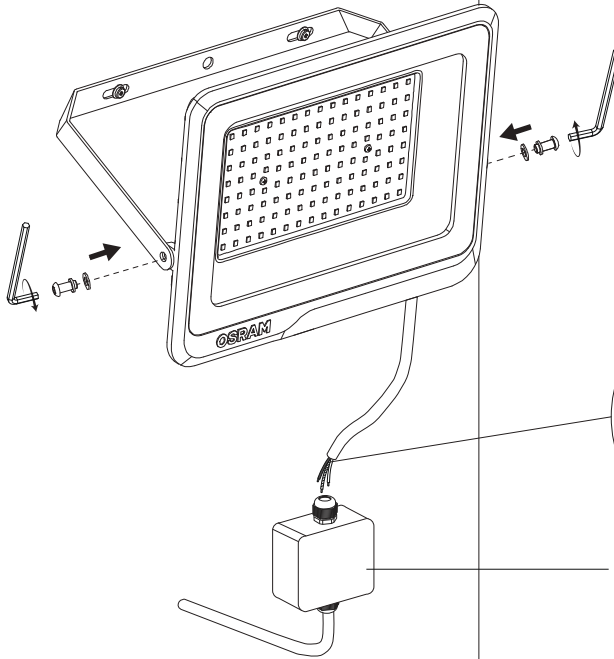

Product	
10W	1.2Nm
20W	1.2Nm
30W	2.5Nm
50W	2.5Nm
100W	2.5Nm
150W	2.5Nm

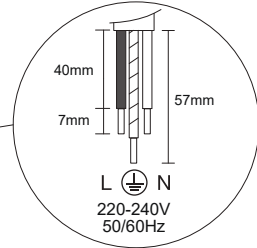

IP65

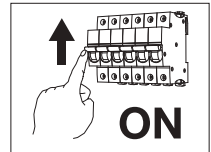

OSRAM is a trademark of OSRAM GmbH.

Traxon is the exclusive licensee of product trademark OSRAM for Professional General Lighting products in Mainland China, Hong Kong and Macau, additional fixed list of General Lighting products.

Service contact:

Traxon Technologies Ltd.  
Room 113, Wireless Centre, 3 Science Park East Avenue, Shatin,  
Hong Kong, China

[www.traxon-ecue.com](http://www.traxon-ecue.com)

Traxon Technologies Europe GmbH  
Karl-Schurz-Str. 38, 33100 Paderborn, Germany



(EN)

- Connect to the power supply in accordance with national regulations.
- The external flexible cable or cord of this luminaire cannot be replaced; if the cord is damaged, the luminaire shall be destroyed.
- The light source of this luminaire is not replaceable; when the light source reaches its end of life the whole luminaire shall be replaced.
- Installation/maintenance only by skilled personnel.
- During overhaul/maintenance only use original parts.
- If any luminaire is subsequently modified, the person responsible for the modification shall be considered the manufacturer.
- The manufacturer bears no liability for damage caused by inappropriate use or application.
- To reduce the risk of strangulation the flexible wiring connected to this luminaire shall be effectively fixed to the wall if the wiring is within arm's reach

(ES)

- La conexión a red debe de realizarse siguiendo las normas específicas de cada país.
- En caso de que el cable externo flexible de esta luminaria este dañado sólo puede reemplazarse por el fabricante o una persona similar cualificada, para evitar peligros.
- El montaje y mantenimiento lo efectuaran únicamente los técnicos especializados.
- Para reparaciones han de emplearse solo piezas originales de recambio.
- Reservado el derecho de modificación de dimensiones, pesos y características técnicas, sin previo aviso.
- El fabricante no asume responsabilidad por modificaciones realizadas por terceros, nip or instalacion incorrecta.

(FR)

- Connexion à l'alimentation conformément aux normes en vigueur.
- Si le câble extérieur souple ou le cordon de ce luminaire est endommagé, il doit être remplacé exclusivement par le fabricant, ou toute personne de qualification équivalente, ceci afin d'éviter tout risque.
- Les opérations d'installation et d'entretien doivent être effectuées exclusivement par des personnes qualifiées.
- Dans le cas d'une remise en état, utiliser uniquement des composants d'origine.
- Toutes modifications apportées au luminaire se feront sous la responsabilité exclusive de celui qui les effectue.
- Le fabricant décline toute responsabilité résultant d'une mise en oeuvre inappropriée du produit.

(DE)

- Netzanschluss bit te nach den länderspezifischen errichtungsbestimmungen tätigen.
- Falls das externe flexible kabel dieser leuchte beschädigt ist, darf es ausschliesslich ersetzt werden durch den hersteller oder einer ähnlich qualifizierten person, um gefahrungen zu vermeiden.
- Montage/wartung nur durch fachkräfte.
- Bei instandsetzung/instandhaltung nur originaleile verwenden.
- Werden nachträglich änderungen an leuchten vorgenommen, so gilt derjenige als hersteller, der diese änderung vornimmt.
- Der hersteller übernimmt keine haftung für schäden, die durch unsachgemässen eininsatz entstehen.

(IT)

- Effet tuare l'allacciamento alla rete secondo le norme di installazione vigenti nel paese d'utilizzo.
- Se il cavo flessibile esterno di questo apparecchio d'illuminazione è danneggiato, per evitare pericoli i esso può essere sostituito esclusivamente dal product tore o da persona dotata di analoga qualifica.
- Montaggio/manutenzione solo per mezzo di personale specializzato.
- Per riparazione/manutenzione impiegare solo parti originali.
- Il costrut tore si riserva il diritto di apportare senza preavviso modifiche di peso, dimensioni e carat teristiche tecniche.
- Il costrut tore non è responsabile per danni derivanti da modifiche realizzate da terzi e da una installazione non corret ta.

(PT)

- Ligar à fonte de alimentação, de acordo com a regulamentação nacional.
- Caso o cabo externo e flexível da luminária se danifique, deve ser substituído pelo fabricante ou pessoa igualmente qualificada, para evitar situações de perigo.
- Montagem/manutenção efectuada unicamente por pessoal técnico especializado.
- Utilizar somente peças originais do fabricante.
- O fabricante não se responsabiliza por danos resultantes da inadequada utilização dos materiais.

(EL)

- ΗΣΥΝΔΕΣΗ ΜΕ ΤΗΝ ΠΛΗΡΟΧ Η ΡΕΥΜΑ Τ ΟΣ ΝΑ ΓΙΝΕΤ Α Ι ΣΥΜΦΩΝ ΝΑ ΜΕ Τ Ι Σ ΕΘΝ Ι Κ Ε Σ Π Ρ Ο Δ Ι Α Γ Ρ Α Φ Ε Σ .
- ΣΕ ΠΕΡΙΠΤ Ω ΣΗ Π Ο Υ Τ Ο ΕΞΩ ΤΕΡ Ι Κ Ο ΕΥΚΑΜΠΤ Ο ΚΑΛ Ω Δ Ι Ο Α Υ Τ Ο Υ Τ Ο Υ ΦΩ Τ Ι Σ Τ Ι Κ Ο Υ ΕΙΝΑ Ι ΚΑ ΤΕΣΤ ΑΜΜ Ε Ν Ο . Π Ρ Ε Π Ι Ν Α Α Ν Τ Ι Κ Α Τ Α Σ Τ Α Θ Ε Ι Α Π Ο Κ Α Ε Ι Σ Τ Ι Κ Α Κ Α Ι Μ Ο Ν Ο Α Π Ο Τ Ο Ν Κ Α Τ Α ΣΚΕ Υ Α Σ Τ Η Η Α Π Ο Α Λ Λ Ο ΕΞ Ω Σ Τ Ο Δ Ο Τ Η Μ Ε Ν Ο Α Τ Ο Μ Ο . Γ Ι Α Τ Η Ν Α Π Ο Φ Ύ Γ Η Κ Κ Ι Ν Δ Υ Ν Ω Ν .
- Τ Ο Π Ο Θ Ε Τ Η Σ Η / Σ Υ Ν Τ Η Ρ Η Σ Η Μ Ο Ν Ο Α Π Ο Η Α Ε Κ Τ Ρ Ο Λ Ο Γ Ο .
- Κ Α Τ Α Τ Η Ν Ε Π Ι Σ Κ Ε Υ Η / Δ Ι Α Τ Η Ρ Η Σ Η Χ Ρ Η Σ Ι Μ Ο Τ Ο Ι Ε Τ Τ Ε Γ Ν Η Σ Ι Α Α Ν Τ Α Λ Λ Α Κ Τ Ι Κ Α Μ Ο Ν Ο .

(SV)

- Nätanslutning skall ske enligt nationella bestämmelser.
- Är den externa flexibla sladden på lampen skadad, får endast tillverkaren eller en annan person med liknande kvalifikationer byta ut denna, för att undvika faror.
- Montering skötsel endast av fackfolk.
- Använd bara originaldelar vid igångsättning/underhåll.

(CZ)

- Připojení k síťovému napětí dle platných národních norem.
- Pokud je externí pružný kabel tohoto svítidla poškozen, smí jeho výměnu provést pouze výrobce nebo podobně kvalifikovaná osoba, aby nedošlo k žádnému ohrožení.
- Montáž a údržba může být i prováděna výhradně odbornou osobou.
- Při údržbě nebo opravě musí být i použit i jen originální náhradní díly.

(HU)

- Csatlakoztassa a tápegységbe a helyi előírásoknak megfelelően.
- Ha ezen lámpák hajlítható/rugalmas kábeleli megsérülnek, akkor azok kizárólag csak a gyártó vagy hasonlón kvalifikált személy által cserélhetők ki, hogy elkerüljék a baleseteket.
- A szerelés/karbantartást csak szakszemélyzet végezheti.
- Üzembehelyezesnél/karbantartásnál csak eredeti alkatrészek használhatók.

(SK)

- Zapojte do el, prívodu podľa predpísaných noriem.
- Ak je externý pružný kábel tohto svietidla poškodený, smie byť nahradený výlučne výrobcom alebo podobne kvalifikovanou osobou, aby sa zabránilo ohrozeniu.
- Montáž/vzdrževanie ľahko izvrší le usretno usposobljena oseba.
- Pri popravil/vzdrževaníh delh se ľahko uporabi jajo samo originalni deli.
- V kolikor se na svetilkah naknadno izvedejo spremembe, se za proizvajalca svetilke smatra tisti, ki je izvedel spremembo.
- proizvajalec ne jamči za škodo, ki bi nastala zaradi nepravilne uporabe.

(HR)

- Molimo izvršite mrežni priključak prema specifičnim nacionalnim odredbama o njegovom izvršenju.
- Ukoliko je eksterni, fleksibilni kabel te svjetiljke oštećen, zamjena istog je dozvoljena isključivo proizvođaču ili sličnoj kvalificiranoj osobi, kako bi se izbjegle opasnosti.
- Montažu/održavanje mora vršiti odgovarajuće osposobljena osoba.
- Pri popravku/održavanju koristiti samo originalne dijelove.
- Ukoliko se na svjetiljkama naknadno vrše promjene, za proizvođača svjetiljke se smatra taj koji je promjene izvršio.
- Proizvođač ne garantuje za štetu koja bi mogla nastati usled nepravilne upotrebe.

(NL)

- Aansluiten op het lichtnet, conform de nationale regelgeving.
- Als het externe flexibele snoer van deze armatuur beschadigd is, mag dit uitsluitend worden vervangen door de fabrikant of een andere gekwalificeerde persoon, om risico's te voorkomen.
- Montage/service alleen door vakkundig personeel.
- Bij inbedrijfstellen/onderhoud alleen originele onderdelen gebruiken.

(NO)

- Koble til strømforsyningen i henhold til nasjonale bestemmelser.
- Hvis den eksterne og fleksible kabelen til denne lampen er skadet, så må den kun skiftes ut av produsenten eller en likeverdig kvalisert person, for at skader unngås.
- Monteres kun av fagpersonell.
- Ved feilretting : bruk kun originaldeler.

(RU)

- Выпо лить по дк ло ч ение к сети в с оответс твии с принятыми в данной с тр ане пр авильныи монт ажа .
- В с луч ае повреждения внеш нег о г ибка о г к абеля т ог о светильник а, ч т обы иск лю ч ить риск и, он до лжен быть заменен т о лк о изг от овителем или лиц ом , имеющ им т акую же к в а лиф ик ац ию .
- При ремонте применять т о лк о т о же с амые ч а с т и .
- Монт аж / об с лужив ание т о лк о специа лист ами .

(PL)

- Zasilanie należy połączyć zgodnie z wymaganiami odpowiednich norm.
- W przypadku uszkodzenia przewodu zasilającego należy go wymienić na nowy, wymiana przewodu może być wykonana jedynie przez wykwalifikowanego elektryka.
- Montaż/konserwacja tylko przez fachowy personel.
- Dla naprawy/bieżącej eksploatacji stosować tylko oryginalne części zamienne.

(TR)

- Sebeye bağıntısını lütfen ülkeye özgü kurulum kuralları çerçevesinde yapınız.
- Avizenin [luminare] harici esnek kablosunun hasar görmesi durumunda, tehlikelerden kaçınmak üzere bu sadece üretici tarafından veya benzeri vasıflı kişiler tarafından değiştirilebilir.
- Montaj ve bakım sadece yetkili personel tarafından yapılmalıdır.
- Bakımda sadece orijinal parçalar kullanılmalıdır.

(SR)

- Molimo da mrežni priključak provedete prema specifičnim nacionalnim odredbama o njegovom provođenju.
- Ako je eksterni fleksibilni kabal ove svetiljke oštećen, njega sme da zameni isključivo proizvođač ili neko slično kvalifikovano lice, da bi se izbegla ugrožavanja.
- Montažu/održava vanje može da obavi samo stručno osposobljena osoba.
- Pri popraviljanju/održavanju upotrebi javati samo originalne delove.
- Ukoliko se na svetilkama naknadno urade izmene, za proizvođača svetilke će se smatrati onaj ko izmene izvrši.
- Proizvođač ne garantuje za štetu koja bi mogla nastati usled nepravilne upotrebe.

(KR)

- 국가 규정에 따라 전원을 연결합니다.
- 램프의 외부 코드 또는 코드는 교체할 수 없으며, 전선이 손상된 경우 램프를 교체하고 파괴해야 합니다.
- 램프의 광원은 교체할 수 없습니다. 광원의 수명이 끝나면 램프 전체를 교체해야 합니다.
- 설치,유지는 숙련된 인력만 할 수 있습니다.
- 점검,유지기간에는 오리지널 부품만 사용하십시오.
- 어떤 등기구 제품이라도 제품이 수정되는 경우 수정한 담당자가 제조업체로 간주됩니다.
- 부적절한 사용 또는 부적절 사용으로 인해 생긴 파손에 대해서는 제조사가 어떠한 책임도 지지 않습니다.
- 목 출림의 위험을 줄이기 위해 램프에 연결된 유연한 전선은 팔이 닿는 범위 내에서 벽에 효과적으로 고정되어야 합니다.